

Package: S-20

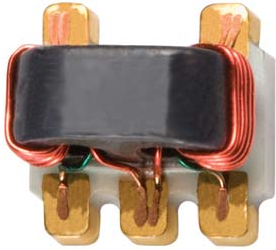

### Features

- Frequency Range 5MHz to 1200MHz
- Low Cost and RoHS Compliant
- Industry Standard SMT package
- Available in Tape-and-Reel
- 75Ω Characteristic Impedance

### Applications

- Broadband/CATV
- Wireless

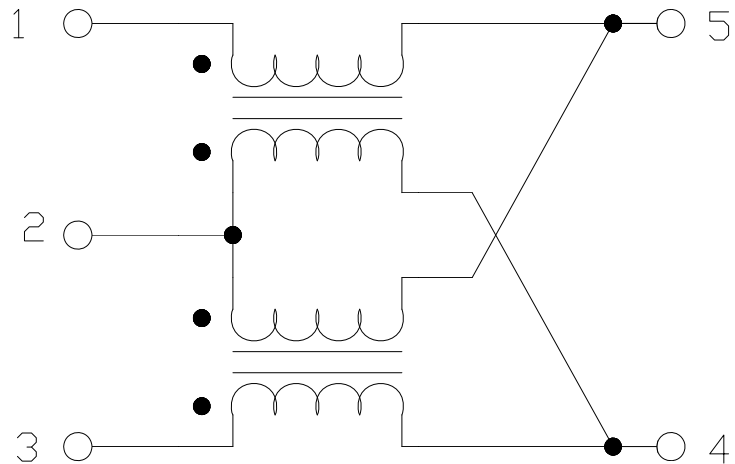

Schematic

### Product Description

The RFCP5773 Coupler is designed for applications that require small, low cost, and highly reliable surface mount components. Applications may be found in broadband, wireless, and other communications systems. These units are built Lead-Free and RoHS compliant. S-Parameters are available on request.

Parameter	Specification			Unit	Condition
	Min.	Typ.	Max.		
<b>Overall</b>					Typical values represent Mid-Band performance at 25 °C
Frequency Range	5		1200	MHz	
Nominal Coupling	19.5	20.0	20.5	dB	
Coupling Flatness	-0.5		+0.5	dB	
Insertion Loss		0.5	0.8	dB	
Directivity	10	20		dB	
Return Loss	14	17		dB	
Characteristic Impedance		75		Ω	

### Absolute Maximum Ratings

Parameter	Rating	Unit
RF Power	2	W
Operating Temperature	-45 to +85	°C
Storage Temperature	-55 to +100	°C



**Caution!** ESD sensitive device.

Exceeding any one or a combination of the Absolute Maximum Rating conditions may cause permanent damage to the device. Extended application of Absolute Maximum Rating conditions to the device may reduce device reliability. Specified typical performance or functional operation of the device under Absolute Maximum Rating conditions is not implied.

The information in this publication is believed to be accurate and reliable. However, no responsibility is assumed by MiniRF, Inc. ("MiniRF") for its use, nor for any infringement of patents, or other rights of third parties, resulting from its use. No license is granted by implication or otherwise under any patent or patent rights of MiniRF. MiniRF reserves the right to change component circuitry, recommended application circuitry and specifications at any time without prior notice.



RoHS (Restriction of Hazardous Substances): Compliant per EU Directive 2002/95/EC.

## Typical Data

Coupling

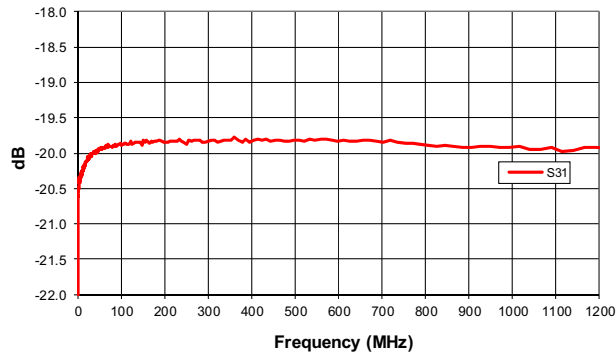

Insertion Loss

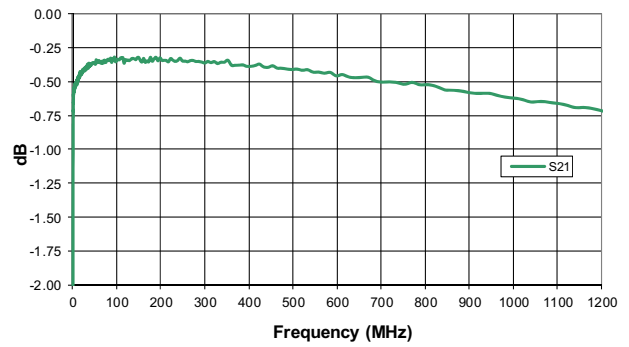

Return Loss

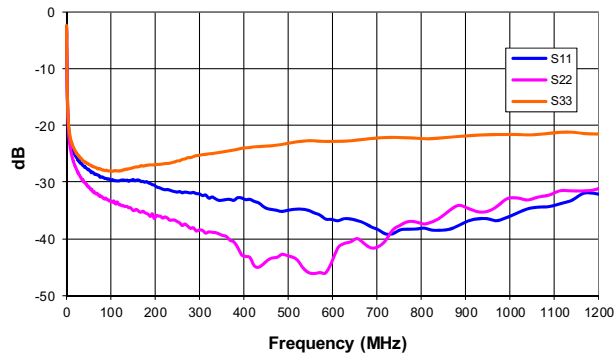

Directivity

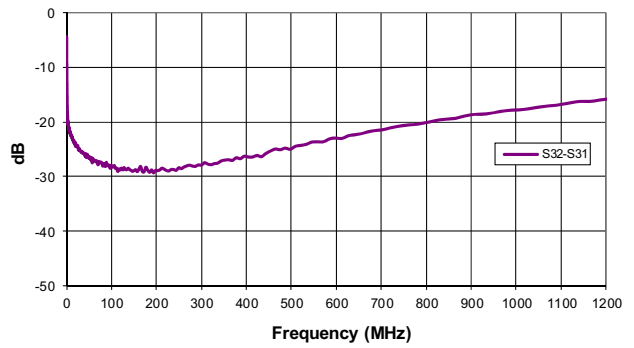

## Pin Names and Description

Pin	Name	Description
1	INPUT	Input
2	GROUND	Ground
3	COUPLED OUTPUT	Coupled Output
4	TERMINATED	Terminated
5	OUTPUT	Output

## Package Drawing - S20

Dimensions in inches (millimeters)

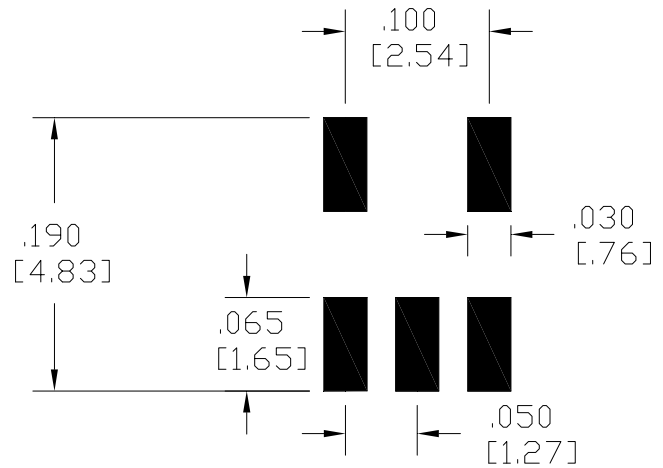
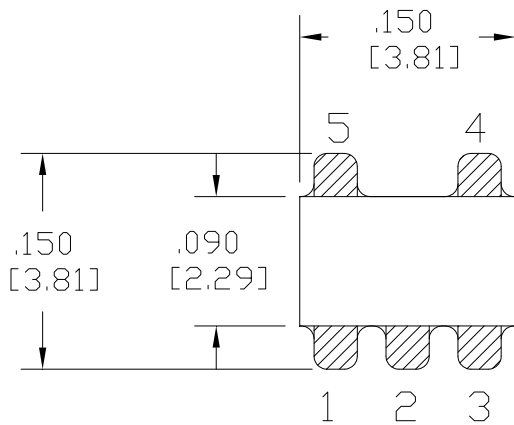

## PCB FOOTPRINT

